

IRIS 80

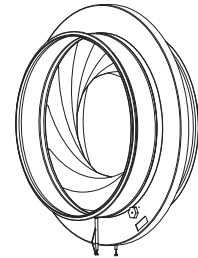

IRIS 100..315



IRIS 400..800

IRIS

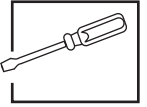
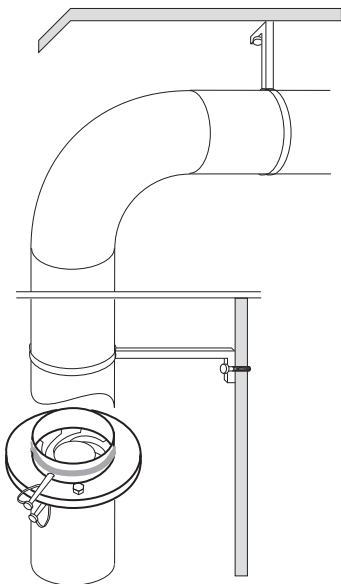
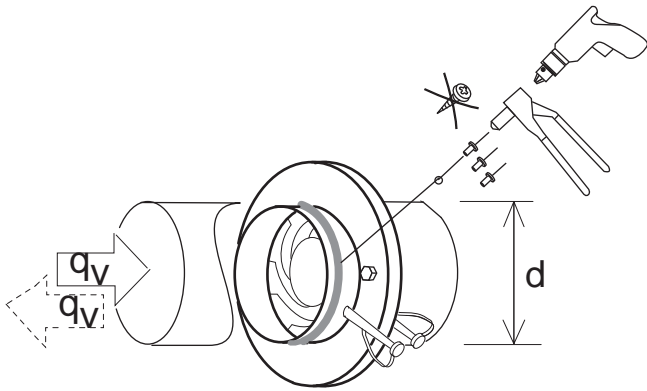

	L_{min}	
	$m_2 = \pm 7\%$	$m_2 = \pm 10\%$
	$\geq 1d$	$\geq 1d$
	$\geq 4d$	$\geq 2d$
	$\geq 2d$	$\geq 2d$
	$\geq 2d$	$\geq 2d$

$m_2 = \pm 5\%$: $L_{min} \geq 10d$

IRIS 80

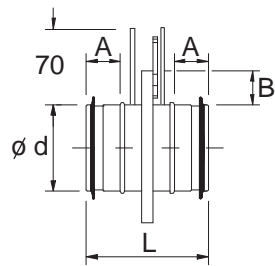
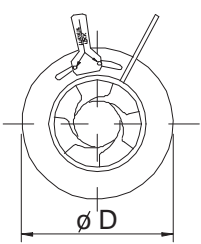

IRIS 100...800

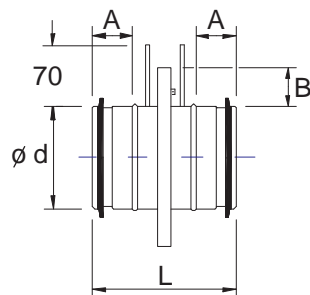
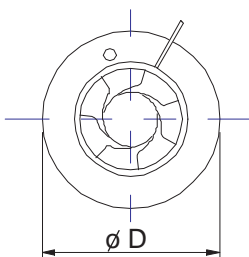

IRIS	$\varnothing d$	$\varnothing D$	L	A	B
80	79	125	120	35	22
100	99	165	110	30	32
125	124	188	110	30	32
150	149	230	110	30	40
160	159	230	110	30	35
200	199	285	110	30	42
250	249	335	132	40	42
315	314	410	132	40	47
400	398	525	150	50	62
500	498	655	150	50	77
630	628	815	150	50	92
800	798	1015	285	100	107

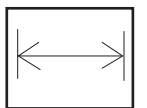

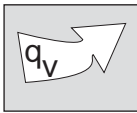

IRIS	k														
	1	1,5	2	2,5	3	3,5	4	4,5	5	5,5	6	6,5	7	7,5	8
80	6,1	-	4,1	-	3,2	-	2,3	-	1,4	-	0,9	-	0,6	-	-
100	10,4	7,9	7,5	6,6	6,0	5,2	4,5	3,8	3,4	2,9	2,5	2,1	1,7	1,2	0,9
125	13,8	10,4	8,8	7,3	6,5	5,5	4,7	4,0	3,5	3,1	2,7	2,2	1,5	-	-
150	24,1	20,0	16,5	14,9	13,4	12,0	11,0	10,0	8,9	7,9	6,9	6,0	5,2	4,4	3,7
160	22,1	17,2	14,8	13,4	12,5	11,5	10,7	9,5	8,5	7,5	6,8	5,6	4,9	4,0	3,5
200	44,2	36,6	30,9	26,9	23,2	20,6	18,2	15,9	14,0	12,3	11,0	9,6	8,4	6,5	5,0
250	64,4	53,5	45,6	41,8	38,7	34,5	30,7	27,3	24,1	21,4	18,4	15,8	12,8	10,9	8,9
315	118,0	88,3	70,0	64,5	58,7	53,0	45,1	42,4	37,0	33,3	30,0	25,9	21,8	19,0	15,8
400	131,0	-	102,0	-	88,3	-	67,3	-	52,7	-	38,5	-	28,4	-	15,5
500	230,0	-	177,0	-	146,0	-	112,0	-	88,5	-	66,6	-	48,0	-	30,0
630	451,0	-	297,0	-	238,0	-	169,0	-	127,0	-	91,6	-	62,8	-	35,1
800	489,0	-	402,0	-	344,0	-	267,0	-	217,0	-	170,0	-	122,0	-	73,7

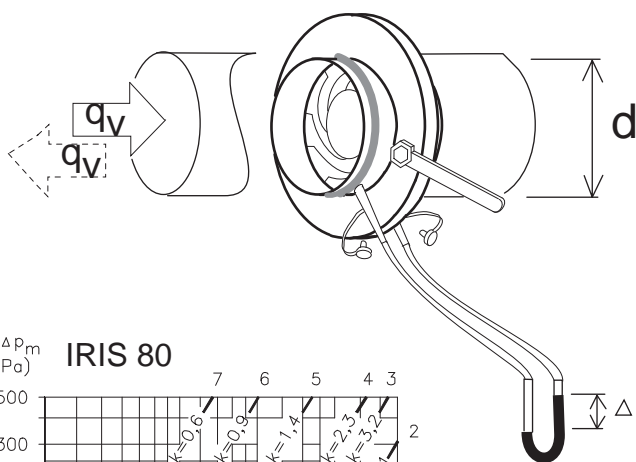

$$q_v = k \sqrt{\Delta P_m}$$

(l/s) (Pa)

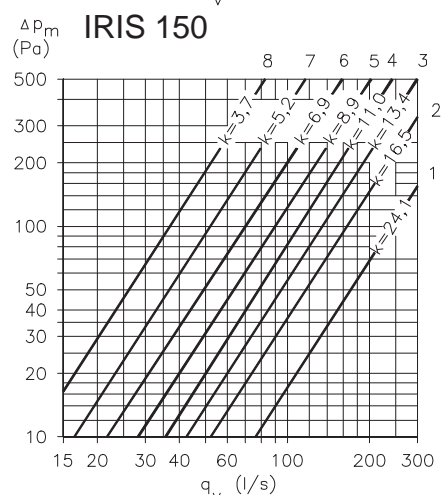
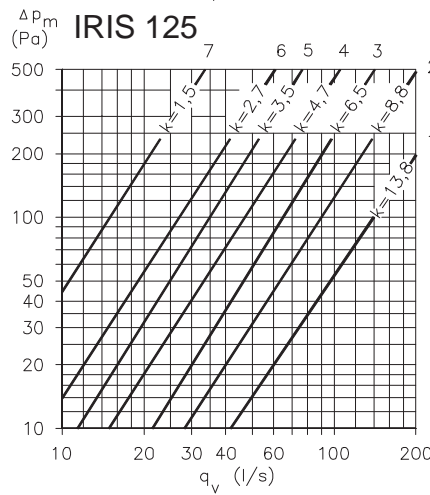
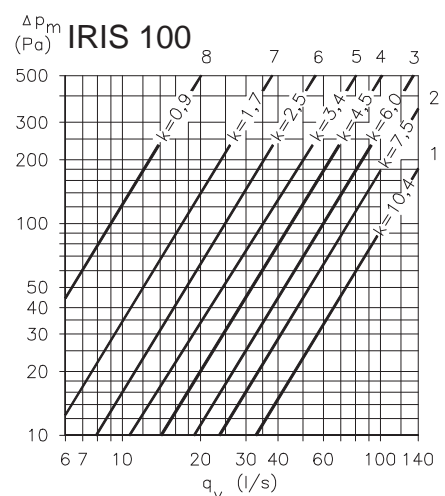
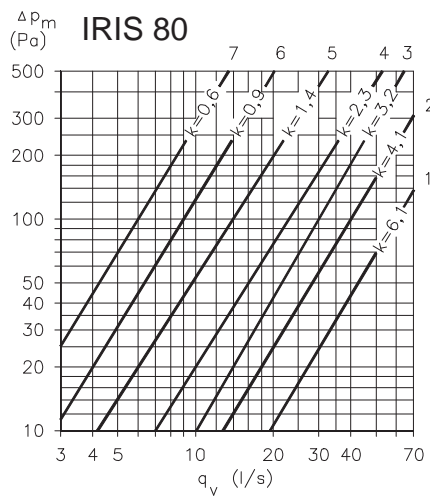

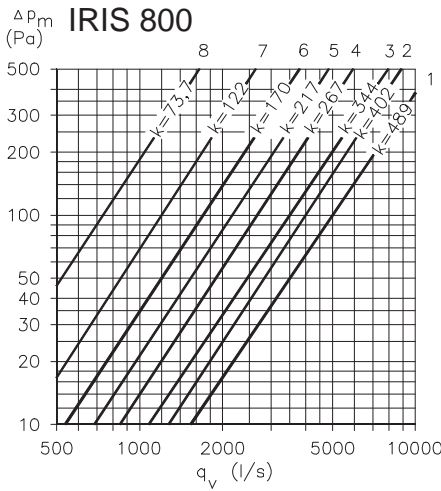
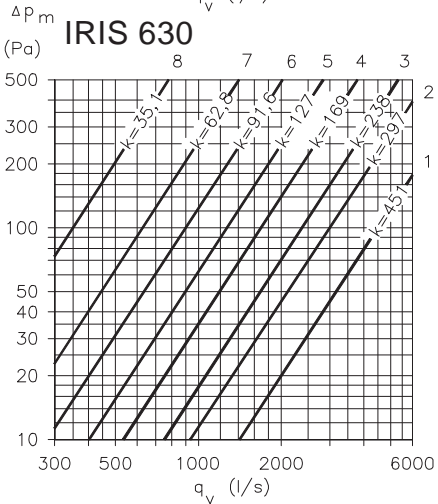
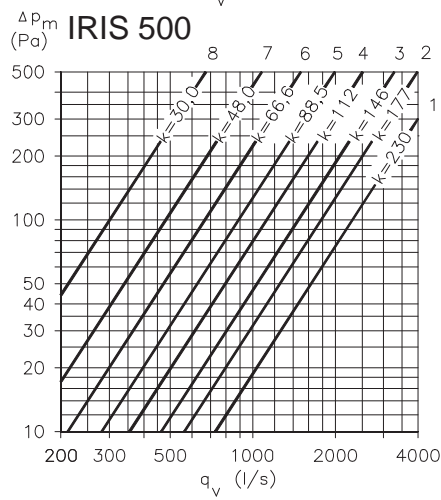
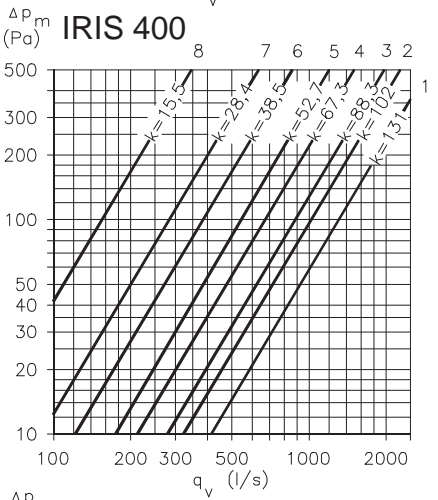
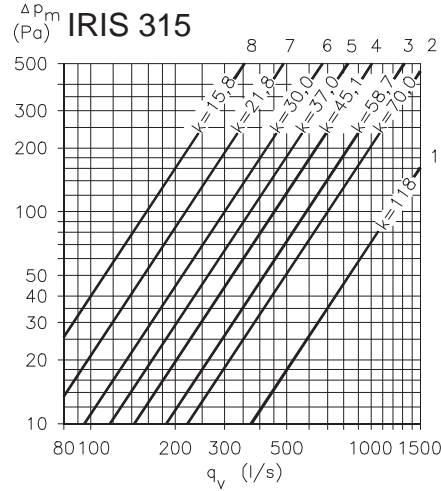
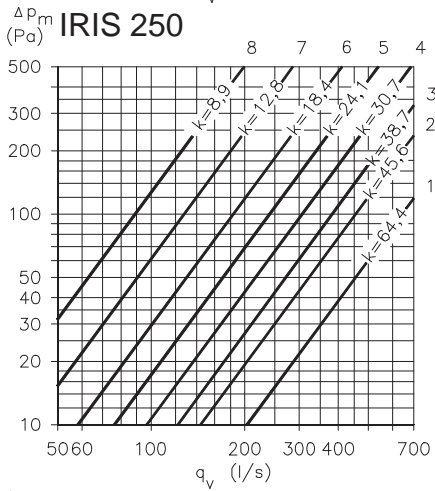
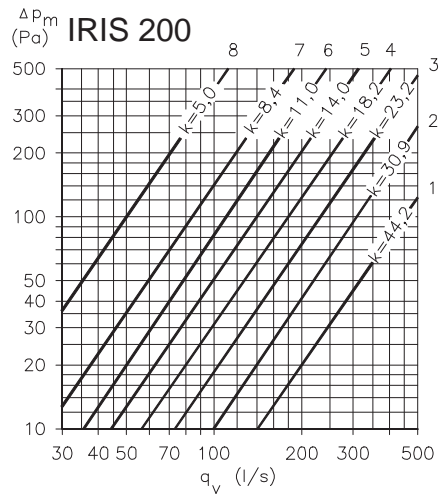
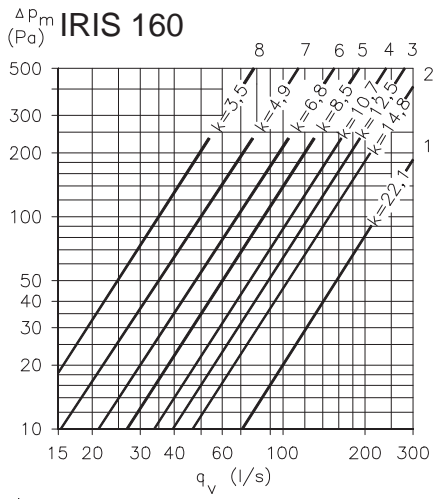

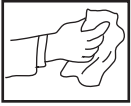

IRIS 80

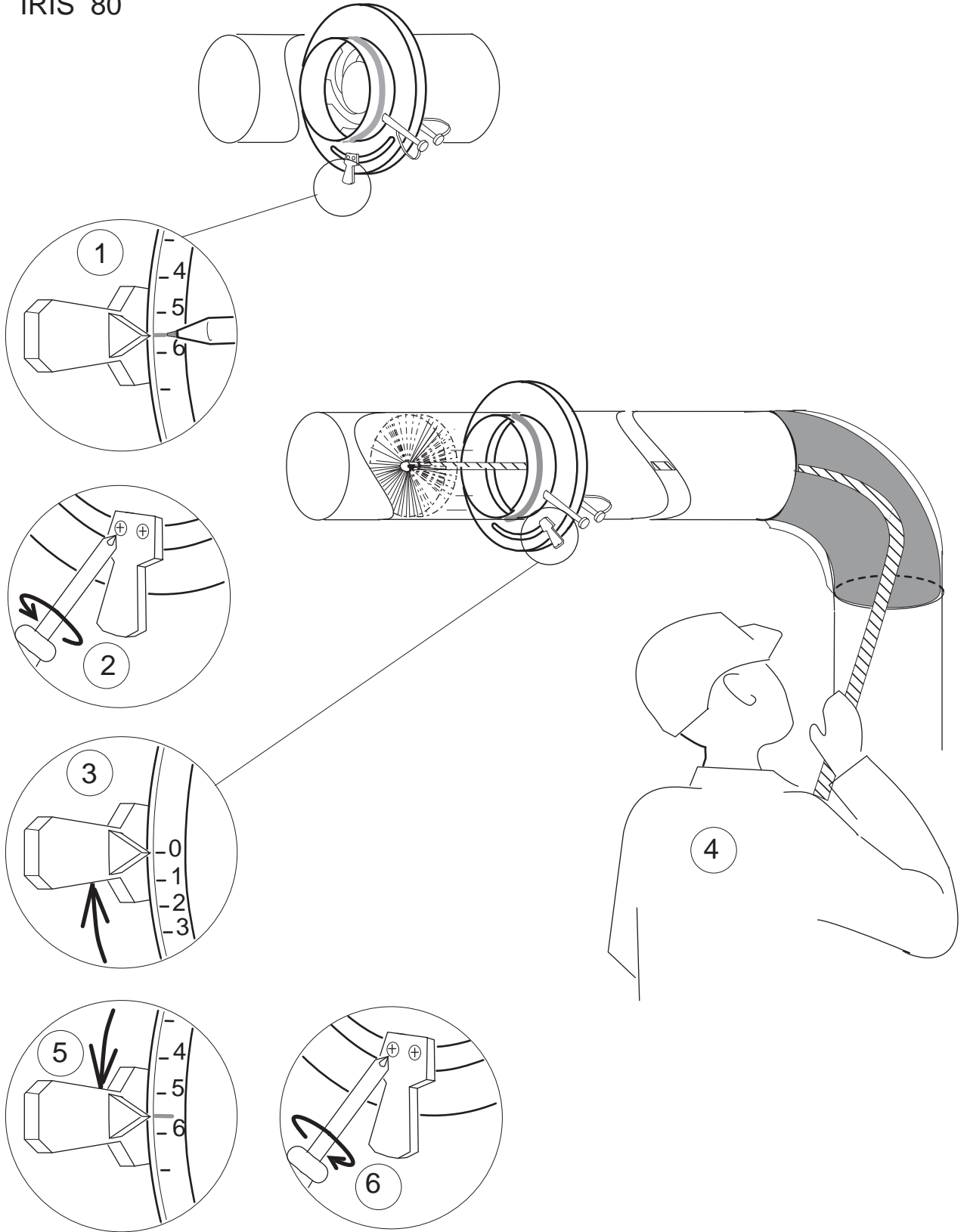

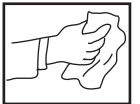

IRIS 100..315

IRIS 400...800

